



Report

US \$44.99

2020 Mercedes-Benz Sprinter 2500

71,055 mi | VIN: W1W4EBVY6LP225410 |
Cargo Van | 3.0L V6 F DOHC 24V | Diesel | All wheel drive

CARFAX HAS THE MOST ACCIDENT & DAMAGE INFORMATION

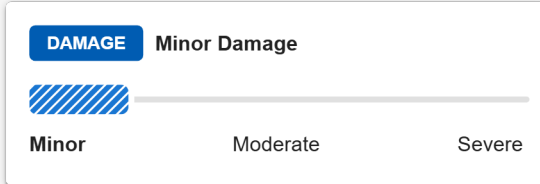

5 Service history records

2 Previous owners

Types of owners: Corporate fleet, Personal

Last owned in California

16 Detailed records available

This CARFAX Vehicle History Report is based only on information supplied to CARFAX and available as of 4/15/26 at 7:13:37 AM (CDT). Other information about this vehicle, including problems, may not have been reported to CARFAX. Use this report as one important tool, along with a vehicle inspection and test drive, to make a better decision about your next used car.



Accident / Damage History

Not all accidents / issues are reported to CARFAX

Event 1

02/17/2023
Damage reported: minor damage

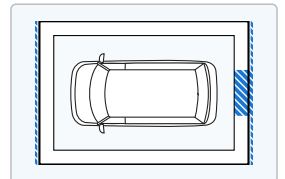
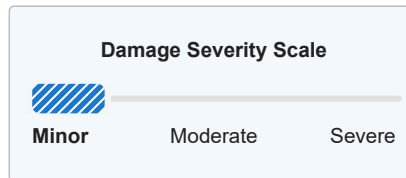

Event 2

07/07/2025
Damage reported: minor damage

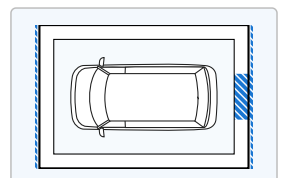
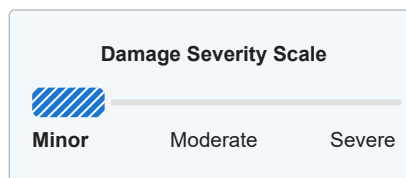

Additional History

Not all accidents / issues are reported to CARFAX



Owner 1

Owner 2

Total Loss No total loss reported to CARFAX.	<input checked="" type="checkbox"/> No Issues Reported	<input checked="" type="checkbox"/> No Issues Reported
Structural Damage CARFAX recommends that you have this vehicle inspected by a collision repair specialist.	<input checked="" type="checkbox"/> No Issues Reported	<input checked="" type="checkbox"/> No Issues Reported
Airbag Deployment No airbag deployment reported to CARFAX.	<input checked="" type="checkbox"/> No Issues Reported	<input checked="" type="checkbox"/> No Issues Reported
Odometer Check No indication of an odometer rollback.	<input checked="" type="checkbox"/> No Issues Indicated	<input checked="" type="checkbox"/> No Issues Indicated
Accident / Damage Damage reported: 02/17/2023 and 07/07/2025.	<input checked="" type="checkbox"/> No Issues Reported	Minor Damage
Manufacturer Recall No open recalls reported to CARFAX.	<input checked="" type="checkbox"/> No Recalls Reported	<input checked="" type="checkbox"/> No Recalls Reported
Basic Warranty Original warranty estimated to have expired.	Warranty Expired	Warranty Expired

CARFAX Title History CARFAX guarantees the information in this section	Owner 1	Owner 2
Damage Brands Salvage Junk Rebuilt Fire Flood Hail Lemon	<input checked="" type="checkbox"/> Guaranteed No Problem	<input checked="" type="checkbox"/> Guaranteed No Problem
Odometer Brands Not Actual Mileage Exceeds Mechanical Limits	<input checked="" type="checkbox"/> Guaranteed No Problem	<input checked="" type="checkbox"/> Guaranteed No Problem
 GUARANTEED - None of these title problems were reported by a U.S. state Department of Motor Vehicles (DMV). If you find that any of these title problems were reported by a DMV and not included in this report, you may qualify. View Terms View Certificate		

CARFAX Ownership History The number of owners is estimated	Owner 1	Owner 2
Year purchased	2020	2022
Type of owner	Corporate fleet	Personal
Estimated length of ownership	1 yr. 6 mo.	3 yrs. 9 mo.
Owned in the following states/provinces	California	California
Estimated miles driven per year	13,738/yr	18,387/yr
Last reported odometer reading	21,095	71,055

CARFAX Detailed History			
 Owner 1 Purchased: 2020		Low mileage! This owner drove less than the industry average of 15,000 miles per year.	Corporate Fleet Vehicle 13,738 mi/yr
Date	Mileage	Source	Comments
09/15/2020	4	Loeber Motors, Inc. Lincolnwood, IL 847-675-1000 loebermotors.com	 Vehicle serviced -Pre-delivery inspection completed -Maintenance inspection completed
09/28/2020		Dublin Honda Dublin, CA 925-828-8030 dublinhonda.com	Vehicle offered for sale
09/29/2020	56	California	Odometer reading reported

Motor Vehicle Dept.
Dublin, CA

10/07/2020

California
Motor Vehicle Dept.
Dublin, CA

Title issued or updated

- First owner reported
- Titled or registered as corporate fleet vehicle

06/30/2021

8,904

Mercedes-Benz of Stockton
Stockton, CA
209-944-5511
berberianmotors.com



Vehicle serviced

- 10,000 mile service performed
- Oil and filter changed
- Power steering checked
- Tire condition and pressure checked
- Tires rotated

04/04/2022

20,476

Dublin Honda
Dublin, CA
925-828-8030
dublinhonda.com

Vehicle offered for sale

04/11/2022

20,479

Mercedes-Benz of Pleasanton
Pleasanton, CA
925-463-2525
mbofpleasanton.com/



Vehicle serviced

- Maintenance inspection completed
- Cabin air filter replaced/cleaned
- Fuel filter replaced
- Oil and filter changed
- Tire condition and pressure checked
- Tires rotated

04/14/2022

Dublin Honda
Dublin, CA
925-828-8030
dublinhonda.com



Vehicle serviced

06/02/2022

20,488

Dublin Honda
Dublin, CA
925-828-8030
dublinhonda.com

Vehicle sold

06/23/2022

21,095

California
Inspection Station

Passed emissions inspection



Owner 2

Purchased: 2022

Personal Vehicle

18,387 mi/yr

Date

Mileage

Source

Comments

06/30/2022

California
Motor Vehicle Dept.
Merced, CA

Title issued or updated

- New owner reported
- Loan or lien reported



Avoid financial headaches. Make sure the loan has been paid off if you're buying from a private seller. [Learn More](#)

02/17/2023

Damage Report

Damage reported: minor damage

- Damage to rear

Damage Severity Scale



Minor

Moderate

Severe

CARFAX HAS THE MOST ACCIDENT & DAMAGE INFORMATION

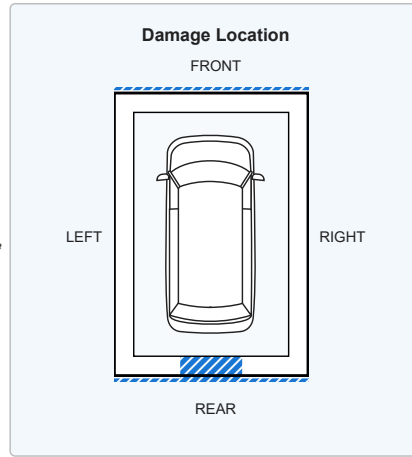

Minor damage is usually cosmetic, including dents or scratches to the vehicle body.

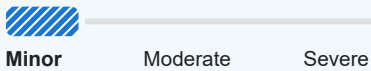
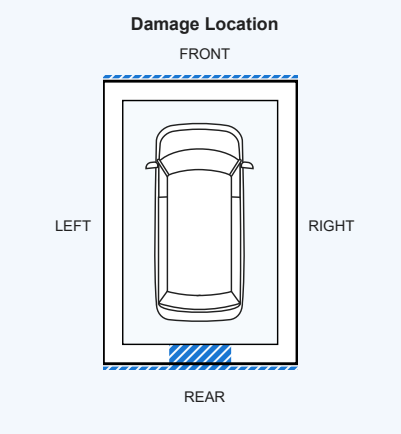
09/28/2023	California Inspection Station	Passed emissions inspection
05/02/2024	45,312 Owl Vans Install Rohnert Park, CA 415-763-2256 owloffroad.com/	 Vehicle serviced
07/07/2025	Damage Report	<p>Damage reported: minor damage -Damage to rear</p> <div data-bbox="844 1003 1253 1157"> <p>Damage Severity Scale</p>  </div> <div data-bbox="844 1171 1253 1619"> <p>Damage Location</p>  </div> <div data-bbox="729 1646 829 1764"> </div> <div data-bbox="873 1654 1505 1722"> <p>Minor damage is usually cosmetic, including dents or scratches to the vehicle body.</p> </div>
09/25/2025	71,055 California Inspection Station	Passed emissions inspection

CARFAX HAS THE MOST ACCIDENT & DAMAGE INFORMATION

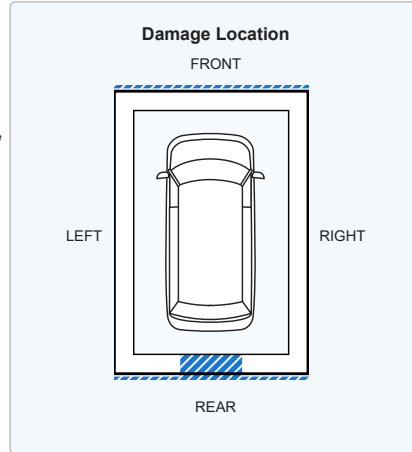

Minor damage is usually cosmetic, including dents or scratches to the vehicle body.

Have Questions? Consumers, please visit our Help Center at www.carfax.com. Dealers or Subscribers, please visit our Help Center at www.carfaxonline.com.

Damage Indicator

Damage can be a result of many different types of events. Examples include contact with objects (other cars, trees, traffic signs, road debris, etc), vandalism, or weather-related events. Not every damage event is reported to CARFAX. As details about the damage event become available, those additional details are added to the CARFAX Vehicle History Report. CARFAX recommends that you have this vehicle inspected by a qualified mechanic.

- This CARFAX Vehicle History Report is based only on information supplied to CARFAX and available as of 4/15/26 at 7:13:37 AM (CDT). Other information about this vehicle, including problems, may not have been reported to CARFAX. Use this report as one important tool, along with a vehicle inspection and test drive, to make a better decision about your next used car.

Damage Severity

Damage events result in one of the following severity levels:

- Minor: Generally, minor damage is cosmetic (including dents or scratches), may only require reconditioning, and typically does not compromise a vehicle's operation and/or safety.
- Moderate: Moderate damage may affect multiple components of the vehicle and may impair the vehicle's operation and/or safety.
- Severe: Severe damage usually affects multiple components of the vehicle and is likely to compromise the vehicle's operation and/or safety.

CARFAX recommends getting a pre-purchase inspection at a certified collision repair facility.

First Owner

When the first owner(s) obtains a title from a Department of Motor Vehicles as proof of ownership.

Fleet Vehicle

Vehicle was registered or sold to a company that manages vehicle fleets.

New Owner Reported

When a vehicle is sold to a new owner, the Title must be transferred to the new owner(s) at a Department of Motor Vehicles.

Ownership History

CARFAX defines an owner as an individual or business that possesses and uses a vehicle. Not all title transactions represent changes in ownership. To provide estimated number of owners, CARFAX proprietary technology analyzes all the events in a vehicle history. Estimated ownership is available for vehicles manufactured after 1991 and titled solely in the US including Puerto Rico. Dealers sometimes opt to take ownership of a vehicle and are required to in the following states: Maine, Massachusetts, New Jersey, Ohio, Oklahoma, Pennsylvania and South Dakota. Please consider this as you review a vehicle's estimated ownership history.

Title Issued

A state issues a title to provide a vehicle owner with proof of ownership. Each title has a unique number. Each title or registration record on a CARFAX report does not necessarily indicate a change in ownership. In Canada, a registration and bill of sale are used as proof of ownership.

[Full Glossary](#)

Follow Us:



[facebook.com/CARFAX](https://www.facebook.com/CARFAX)



[@CARFAXinc](https://twitter.com/CARFAXinc)



[About CARFAX](#)

CARFAX DEPENDS ON ITS SOURCES FOR THE ACCURACY AND RELIABILITY OF ITS INFORMATION. THEREFORE, NO RESPONSIBILITY IS ASSUMED BY CARFAX OR ITS AGENTS FOR ERRORS OR OMISSIONS IN THIS REPORT. CARFAX FURTHER EXPRESSLY DISCLAIMS ALL WARRANTIES, EXPRESS OR IMPLIED, INCLUDING ANY IMPLIED WARRANTIES OF MERCHANTABILITY OR FITNESS FOR A PARTICULAR PURPOSE.

© 2026 CARFAX, Inc., part of S&P Global. All rights reserved.
4/15/26 7:13:37 AM (CDT)

I have reviewed and received a copy of the CARFAX Vehicle History Report for this 2020 MERCEDES-BENZ SPRINTER vehicle (VIN: W1W4EBVY6LP225410), which is based on information supplied to CARFAX and available as of 4/15/26 at 8:13 AM (EDT).

Customer Signature

Date

Dealer Signature

Date

